

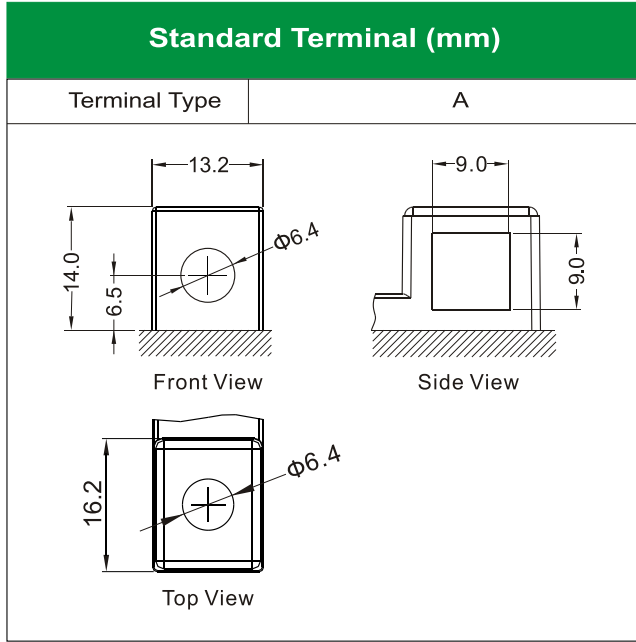

LEOCH BATTERY
EBX20L-BS (12V18Ah)

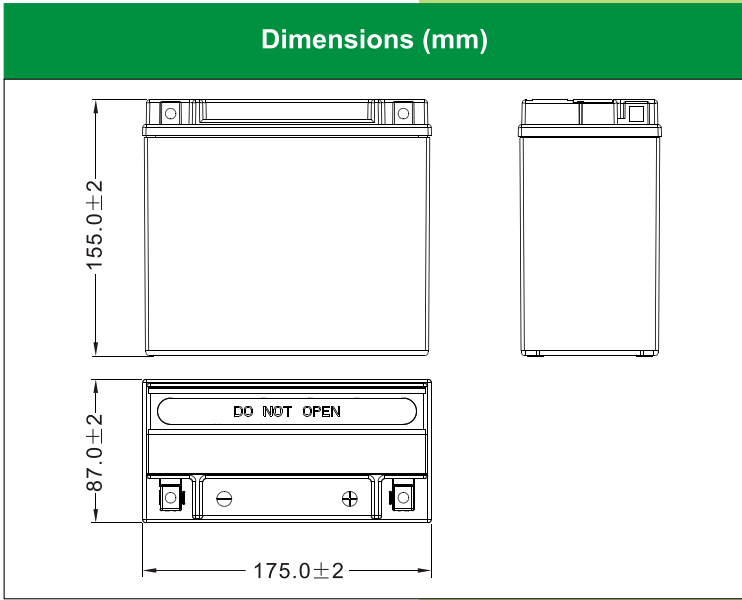

Physical Specification

Nominal Voltage	12V	
Nominal Capacity (10HR)	18Ah	
Dimension	Length	175 ± 2mm (6.89 inches)
	Width	87 ± 2mm (3.43 inches)
	Container Height	155 ± 2mm (6.10 inches)
	Total Height (with Terminal)	155 ± 2mm (6.10 inches)
Weight	Battery(with acid): Approx 5.94kg (13.10lbs)	
	Electrolyte: Approx 1.17kg (2.58lbs)	

- * Sealed AGM battery
- * Fresh Pack, Maintenance Free
- * Powerful 270 cold cranking amps
- * Rest after filling acid
- * Maximum tilt angle for installation: 25°

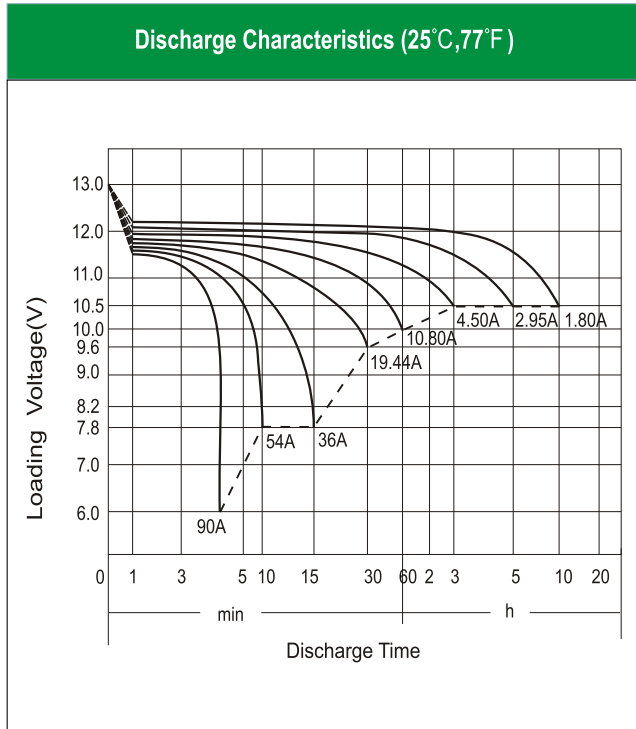

Electrical Specification

Rated Capacity	10 hour rate (1.80 A)	18.00Ah
	5 hour rate (2.95 A)	14.76Ah
	2 hour rate (6.30 A)	12.60Ah
	1 hour rate (10.80 A)	10.80Ah
	0.5 hour rate (19.44 A)	9.72Ah
Capacity affected by Temperature	40 °C (104 °F)	106%
	25 °C (77 °F)	100%
	0 °C (32 °F)	86%
	-15 °C (5 °F)	65%
Charging Methods	Full Charge	Constant-Voltage Charge: Initial charging current: less than 5.4A Voltage: 14.40 V ~ 15.00 V at 25 °C (77 °F) Charging time: 15 ~18h Constant-Current Charge: Charging current: 0.1C ₁₀ =1.80A, when charging voltage up to 14.40V, continue to charge 4h
	Floating Charge	No limit on Initial charging current Voltage: 13.50 V ~ 13.80 V at 25 °C (77 °F)